

Jurnal PROtek

by Varkhan Bijaksana

Submission date: 19-Jun-2023 09:25PM (UTC+0700)

Submission ID: 2119079832

File name: Jurnal_PROtek_Varkhan_Bijaksana.docx (216.79K)

Word count: 4744

Character count: 24528

Electricity Potential by Bioethanol Fuel from Pineapple Skin Waste, Kualu Nanas Village, Kampar Regency, Riau

Varkhan Bijaksana

UIN Sultan Syarif Kasim Riau
(Department of Electrical

9 Engineering,)

Jl. HR. Soebrantas Simpang

Baru, Pekanbaru.28293,

Indonesia email :

11950514763@students.uin-suska.ac.id

Nanda Putri Miefthawati

UIN Sultan Syarif Kasim Riau
(Department of Electrical

9 Engineering,)

Jl. HR. Soebrantas Simpang

Baru, Pekanbaru.28293,

Indonesia email :

nandamiefthawati@uin-suska.ac.id

Abstract – Kualu Nenas was a pineapple producer in Riau which produced 4 tons of pineapples a day. This production produced 36 tons a month of waste. This waste created problems for environment, including odor and methane gas, whereas pineapple peel waste included glucose, which can be used to produce bioethanol. This study aimed to analyze the bioethanol potential of pineapple peel and the potential for electricity and power, calculate the values of TFC, SFC, efficiency of the fuel mixture, which were tested on an 8 kW generator in 30 minutes. This research uses fermentation and distillation methods which are simulated by a superpro designer. From the research conducted, the potential for bioethanol was 6,262.63 L/month or 68,871.54 L/year with an ethanol content of 99.9995% and 0.0005% water. The electricity is 75.39 MWh/month for E0, 71.98 MWh/month for E10, and 46.88 MWh/month for E100. The power potential generated is 3.14MW/month for E0, 2.99MW/month for E10, and 1.95 MW/month for E100. From testing with an 8kW generator, the TFCs of E0, E10, and E100 fuels were 0.834, 0.835, and 0.839 liters/hour. While the SFC of E0, E10, and E100 fuels were 0.1043, 0.1044, and 0.1049 liters/hour, with efficiencies of 50.82%, 52.98%, and 80.95%.

Keywords : Electricity, Bioethanol, Pineapple Skin Waste.



13
Creative Commons Attribution-NonCommercial-ShareAlike 4.0 International License.

I. INTRODUCTION

Pineapple, which has the Latin name Ananas Comosus L, is a fruit that is full of nutrients which is useful for the body in every part of the fruit. Pineapple fruit contains a variety of nutrients, including protein, fat, carbohydrates, and vitamins[1]. So far, pineapple has been used as a fresh drink such as pineapple juice, but over time, more processed products with pineapple as raw material, including lunthead, jam, and even pineapple chips[2]. Pineapple is also a tropical fruit commodity that is often found in Indonesia. This is not without reason, the data states that pineapple

production accounts for 8.75% of the total production of all types of fruit in Indonesia. In addition, viewed from prospects, pineapple is a promising commodity to become a leading fruit product in Indonesia. Based on data from 2008 to 2010, pineapple production in Indonesia averaged 1.46 million tonnes a year[3]. in 2014 based on fixed figures (ATAP), pineapple production in Indonesia totaled 1.84 million tonnes which then placed Indonesia as the third largest pineapple-producing country after the Philippines and Thailand with a contribution of approximately 23%[4].

As a large production of pineapples in Indonesia, one of the provinces that contributes to potential pineapple production is Riau Province. Data from 2015 stated that Riau managed to produce 7,308 tons of pineapples in 2015[5]. The amount of pineapple production in Riau Province was contributed by pineapple production in Kampar Regency, especially in 2 villages in the Mining District, namely Rimbo Panjang Village and Kualu Nanas Village. The total area of pineapple cultivation in the 2 villages is 500 and 1050 ha respectively[6]. From these 2 cultivation areas, the Tambang District managed to produce 12,750 tons of pineapples obtained from 13,250,000 trees in the land area, with the largest pineapple production area in Kualu Nanas Village with the production of 4 tons of pineapples a day.

The large production of pineapple certainly has a domino effect on the production of waste generated from this commodity. it is assumed that 30% of the pineapple is the skin, then the amount of pineapple skin waste in Indonesia reaches 22,444 tons [7]. The pineapple skin waste has caused several problems that are felt directly by the community, including creating piles of garbage that smell bad thus it pollutes the air quality and the stench invites flies which have the potential to become disease transmitters to humans [8]. Pineapple skin still has nutritional value that can still be utilized. Pineapple skin contains 88.9503% dry

matter, 3.8257% ash, 27.0911% crude fiber, 8.7809% crude protein, and 1.1544% bad fats[7].

Pineapple also has a high nutrient content, especially carbohydrates and sugar. According to pineapple, it has a water content of 81.72%, fiber of 20.87%, carbohydrates of 17.53%, protein of 17.53%, and reducing sugar of 13.65% [8]. With this high sugar content, pineapple skin has the potential to be processed into a new energy source, namely bioethanol using the fermentation method[9]. Bioethanol with the chemical formula C_2H_5OH is a type of ethanol produced from the glucose fermentation process with the help of yeast. The yeast commonly used is *Saccharomyces cerevisiae*[10]. The results of this fermentation are then distilled with the distillation stage to separate the pure alcohol and the water content that is still together. Bioethanol has several characteristics, including colorless, volatile, and insoluble in water[11][12]. In addition, ethanol also has a boiling point of 78.3C and can freeze at -117.3C, with a density of 0.789 at 20[13] [14].

In the other studies related to the utilization of pineapple peel waste, all research is still focused on variations in the use of enzymes and types of yeast and the length of the process to produce the most optimal bioethanol. Further studies regarding the use of bioethanol from pineapple peel waste as fuel for generators that produce electricity along with an analysis of its costs have not yet been carried out. Therefore this research has the aim of producing bioethanol potential that can be produced from pineapple peel waste in the village of Kualu Nanas, Tambang, Riau. The potential for bioethanol is obtained from simulation results using the superpro application using the fermentation and distillation methods. The choice of this method is because pineapple skin is classified as class 2 bioethanol with glucose content, so processing to produce ethanol optimally can be accomplished by using the fermentation method, while the analysis of the electrical potential that can be generated from various **18** blends of bioethanol mixtures, E10 (10% ethanol, 90% gasoline), E100 (100% ethanol, 0% gasoline), and E0 (0% ethanol, 100% gasoline), along with the value of total consumption as well as specific fuel consumption and efficiency if the fuel is tested with a generator with a capacity of 8kW with a test time of 30 minutes using a mathematical calculation method.

II. BASIC OF THEORY (BIOETHANOL PRODUCTION STEP)

A. Pretreatment

The pretreatment stages were the initial stage in the process of making bioethanol, in this stage the raw material gets pre-treated before being processed, such as the crushing process with a grinder and mixing with water. This stage aimed to facilitate the process of processing and forming bioethanol, thus the ethanol produced can be more optimal.

B. Hydrolysis

Hydrolysis was a process of decomposition or breaking of water with a reactant in a compound that occurs in the first order. Due to the excess water content, there were no changes in the reactants. Hydrolysis can occur in 4 ways, namely pure hydrolysis with water without a catalyst, hydrolysis with acid as a catalyst, hydrolysis with a concentrated base thus the reaction goes more perfectly, and hydrolysis with enzymes such as bacteria or living cells. For hydrolysis used the method with the amylase enzyme because of its advantages that can degrade the activation energy that is has an impact on the faster breakdown of the saccharide polymer chain into the sugar monomers that make up it.

C. Fermentation

Fermentation was the stage where organic compounds in a raw material break down or are broken down into products in the form of organic acids containing alcohol which release energy through a process that takes place without air or is anaerobic. In this stage, several supporting factors have a major influence on the resulting output, these factors include the degree of acidity, the type of bacteria used, temperature, oxygen level, and nutrition.

D. Distillation

Distillation was the final stage in the process of processing raw materials into bioethanol. In this stage, the water content will be separated from the alcohol content produced thus the quality of bioethanol can be increased, because the more water in an alcohol solution, the lower the quality of the ethanol because water can inhibit the ethanol burning process. With this method, the quality of ethanol can be increased to 95%. This distillation occurs with a separation method based on differences in the boiling points of a substance. Pure ethanol has a boiling point of 78OC. To further improve the quality of the ethanol produced, dehydration can be carried out which can improve the ethanol content becomes 99.5%, which means dehydrating the remaining 4.5% water content

III. METHOD AND DESIGN

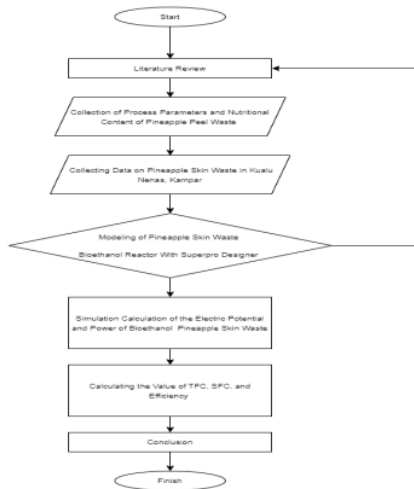

Figure 1. Research Flowchart

A. Process Data Collection and Process Parameter Collection

1. Data Collection

The data used for this research material uses secondary data obtained from reference sources of previous research. The data obtained include[5] :

Table 1. Data on the Potential of Pineapple Peel Waste in Kualu Nanas Village

| No | Parameter | Information |
|----|----------------------------|-----------------------|
| 1 | Pineapple Garden Area | 800ha |
| 2 | Total Pineapple Production | 4 tons/day |
| 3 | Number of Pineapple Trees | 4,157 pineapple trees |

Based on reference [7], it is stated that for every 1 pineapple, the percentage of pineapple skin waste produced is 30% of the total weight of the pineapple. Thusif pineapple production in Kualu Nanas Village is 4 tons per day, then the total pineapple skin that becomes waste in the area is 1.2 tons or 1,200 kg.

2. Process Parameters

Process parameters are parameters that serve as references and input materials in the processing of pineapple peel waste into bioethanol using superpro designer simulations. The process parameters in this study include :

Table 2 Pineapple Skin Nutritional Content[7]

| No | Nutrient content | Mark |
|----|--------------------|--------|
| 1 | Protein (%) | 4,41% |
| 2 | Crude Fiber(%) | 20,87% |
| 3 | Carbs (%) | 17,53% |
| 4 | Reducing Sugar (%) | 13,65% |

| | | |
|---|---------|--------|
| 5 | Air (%) | 43,54% |
| | Total | 100% |

Table 3. Parameter Stock Mixture[15]

| No | Variable | Value (Kg/Batch) |
|----|----------|------------------|
| 1 | Air | 100 |
| 2 | Water | 10 |

Table 4 Mixed Fuel Characteristic Value [15]

| No | Fuel Mixture | LHV Value (KJ/Kg) | Density (g/m3) |
|----|------------------------------------|-------------------|----------------|
| | E0 (Gasoline 100%, Bioetanol 0%) | 43.340 | 0,7150 |
| 2 | E10 (Gasoline 10%, Bioetanol 90%) | 41.381,95 | 0,7154 |
| 3 | E100 (Gasoline 0%, Bioetanol 100%) | 26.950 | 0,7190 |

Table 5 Comparison of LHV Characteristics of Various Fuel Mixtures [15]

| No | Fuel Mixture | LHV Value (BTU/Gal) |
|----|------------------------------------|---------------------|
| 1 | E0 (Gasoline 100%, Bioetanol 0%) | 115.400 |
| 2 | E10 (Gasoline 10%, Bioetanol 90%) | 114.300 |
| 3 | E100 (Gasoline 0%, Bioetanol 100%) | 75.700 |
| 4 | Diesel (B0) | 128.700 |
| 5 | Biodiesel (B100) | 117.100 |

Table 6 Specifications for 8000 Watt Bioethanol Fuel Test Generators

| No | Parameter | Mark |
|----|------------------------------|------------------------------|
| 1 | Generator Type | Champion Generator 8000 Watt |
| 2 | Genset Maximum Power Output | (CPG9000E2) |
| 3 | LevelNoise | 8000 Watt |
| 4 | Power When Genset Is Running | 74dBA @7m |
| 5 | Average Power | 7500 Watt |
| 6 | Frequency | 7000 Watt |
| 7 | Machine | 50 Hertz |
| 8 | Parameter | 459 cc |

B. Bioethanol Production Process with Superpro Simulation

In producing research results on the potential of bioethanol and its electrical potential which can be obtained from pineapple peel waste, the stages of the manufacturing process are as follows:

Table 7 Stages of Making a Simulation in the Superpro Application [15]

| No | Process | Information |
|----|--|---|
| 1 | Defining Process Models | The mode used is modebatch. This mode was chosen because of its advantage that it can change parameters while the scheduling process is running |
| 2 | ChargingPure Components and Stock Mixtures | This stage is the process of filling the nutritional content and raw materials that will be reacted in the superpro designer simulation |
| 3 | Reactor Selection and Parameter Filling | At this stage, reactors are selected that have their respective tasks in the simulation that is run for obtaining bioethanol potential from pineapple peel waste. |
| 4 | Running Simulation | Is the stage of running a simulation to obtain results in the form of bioethanol potential and investment cost analysis |

C. Mathematical Calculations

1. Calculation of Potential Electrical Energy

To produce potential electrical energy from pineapple skin waste bioethanol, you can use the following mathematical equation [15]:

$$\text{Electrical Energy} = \text{Volumetric Flow} \times \text{LHV} \quad (1)$$

Electrical energy = Electrical energy that can be generated from bioethanol from pineapple peel waste (kWh)

Volumetric Flow = Volume flow rate of pineapple peel waste bioethanol from superpro simulation (Kg)

LHV = Calorific value in the condition of water and hydrogen gas in the vapor phase (KJ/Kg)

2. Calculation of Power Potential

To find out the power potential of pineapple peel waste bioethanol, it can be calculated using equation [15]

$$\text{Power potential} = \text{Electrical Energy} / 24 \text{ hours} \quad (2)$$

Electrical Energy = Electrical energy of bioethanol from pineapple peel waste (kWh)

24 Hours = Time in 1 day

3. Calculation of TFC Value (By Testing Method with 8 kW Genset Using Mathematical Calculations)

Total fuel consumption (TFC) or total fuel consumption is the amount of fuel needed or

consumed by the generator at one time according to the capacity of the generator or existing engines. TFC can be calculated using the following equation[15]:

$$\text{TFC} = (m \times \rho \times 3600) / (1000 \times 1800s) \quad (3)$$

TFC = Total Fuel Consumption (Kg/hr, if converted to L/h = x 1.272)

m = Fuel Burette reading (in cc)

Rho = Fuel Density Value (gr/cc)

1000 = Time Period

4. Calculation of SFC Value (By Testing Method with 8 kW Genset Using Mathematical Calculations)

Specific Fuel Consumption (SFC) or specific fuel consumption is a parameter that makes it possible to do a comparison of each fuel mixture to then calculate and determine the type of fuel that is most efficient with the use of the least amount of fuel to generate the same engine capacity. For calculations SFC, can be done with the following mathematical calculations:

$$\text{SFC} = (\text{TFC}) / (\text{Generator Power}) \quad (4)$$

SFC = Specific Fuel Consumption

TFC = Total Genset Power Fuel

Genset Power = Genset Output Power Value

5. Calculation of Efficiency Value (By Testing Method with 8 kW Genset Using Mathematical Calculations)

Efficiency is a comparison value between the power output generated by the generator and the power that can be generated by the fuel. As for this test, the mathematical equation to calculate the efficiency value is as follows[15]:

$$\text{Efficiency} = (1800 \times P) / (\text{TFC} \times \text{LHV}) \times 100\% \quad (5)$$

Efficiency = Comparison between generator power output and fuel power (%)

Power = OneRunning Genset (kW)

TFC = Total Fuel Consumption

LHV = Calorific value in the condition of water and hydrogen gas in the vapor phase (KJ/Kg)

The choice of an 8 kW generator in the mathematical testing process to obtain TFC, SFC, and fuel efficiency values for each fuel mixture is not without reason. The test was carried out using a mathematical equation because there is no generator in the area, thus it is necessary to test it first if the fuel is applied to the generator. The tested fuel is proven to have a quality that can be applied to turn on generators in generating electricity. The generator set chosen for the trial (8kW generator) was also chosen because of the complete specification data which is useful for performing mathematical calculations related to TFC,

SFC, and efficiency thereby increasing the accuracy of the data.

IV. RESULTS AND DISCUSSION

A. Bioethanol Potential of Pineapple Skin Waste

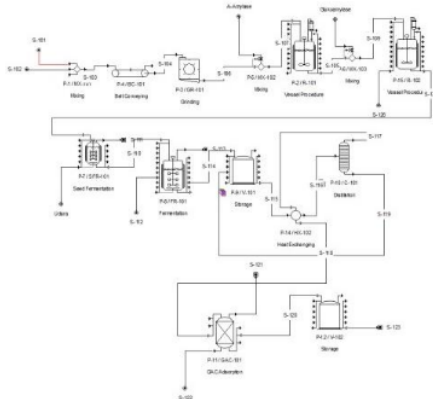

Figure 2. Simulation of a Pineapple Skin Waste Bioethanol Reactor Using the Superpro

Figure 2 is a model of a bioethanol processing reactor with raw material for pineapple peel waste. In the simulation, several reactors are used which have functions according to the reactors in the method section. In this simulation, pineapple skin is used as input to the reactor mixing. The input entered is following secondary data on the number of potential pineapple peels in the village of Kualu Nanas, Tambang, Kampar. The content included in the superpro application is following the content in pineapple skin waste according to Table 2. Table 3 is the data input table for the supporting components of the process of processing pineapple skin waste into bioethanol. Water in the supporting components is used to assist the process of making bioethanol in hydrolysis and fermentation processes. With a total production of 4 tons/day, and based on the reference that each pineapple contains 30% waste derived from its skin, the total input of raw material for pineapple skin which is input to the superpro simulation can be calculated at 1.2 tons. The results of the process of forming bioethanol from pineapple skin waste using the superpro application are as follows :

Table 8 Bioethanol Potential of Pineapple Skin Waste Using Superpro Simulation

| No | Parameter | Mark |
|----|---|--|
| 1 | Amount of Pineapple Skin Waste (Tons) | 1.2 tons a day |
| 2 | Volume Flow Rate(Volumetric Flow) In Liters | 6,262.63L a Month or 68,871.54L a Year |

| | Percentage of Distillation Results in Percent | Ethanol 99,9995%, Water 0.0005% |
|---|---|---------------------------------|
| 3 | | |

The table shows the results of the processing of pineapple peel raw materials which are processed into bioethanol. From the input of raw materials of 1.2 tons a day, the yield of bioethanol is 6,262.63 L a month or 68,871.54 L a year. In addition, the level of bioethanol obtained from pineapple skin waste is also very good, because it contains 99.9995% ethyl alcohol, an amount that exceeds the minimum standard of good fuel, namely 95%. The water content possessed by bioethanol derived from pineapple skin waste is also very low, which is only around 0.0005%. This low water content will certainly improve the quality of bioethanol which can be produced from pineapple peel waste thus the fuel is suitable for use as fuel for generators to generate electricity.

B. Potential of Electrical Energy and Bioethanol Power of Pineapple Peel Waste (E0, E10 and E100)

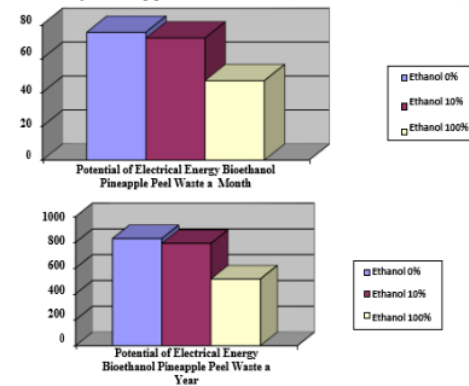

Figure 3 Graph of Potential Electrical Energy that Can be Generated by Pineapple Skin Waste Bioethanol with Various Fuel Mixtures/Month and/Year

By using equation 1, it can be obtained the value of the potential electrical energy of bioethanol from pineapple peel waste in the village of Kualu Nanas, Kampar. The calculation is done by entering several calculation variables, including the value volumetric flow obtained from the simulation results with superpro and the low calorific value obtained from reference materials. The electric potential (in MWh) produced by each fuel mixture, starting from E0 or 100% pure gasoline, E10 (10% Ethanol, 90% Gasoline), and E100 (100% pure Ethanol without a mixture of gasoline) varies. The best ethanol value is produced from E0 fuel or pure gasoline, and the lowest is produced by E100 fuel or pure ethanol. This is due to the low calorific value (LHV) of ethanol, which causes the electrical potential that can be generated to be also low. Inversely proportional to the LHV value

of good gasoline fuel. However, the low electrical potential produced by pure bioethanol from pineapple peel waste can be found in a solution, namely by mixing the 2 types of fuel with a percentage of E10 (Ethanol 10%, gasoline 90%). By mixing the 2 types of fuel with the appropriate percentage, a potential value of electrical energy both per month and per year is obtained which is close to the potential value of electricity from E0 fuel or pure gasoline.

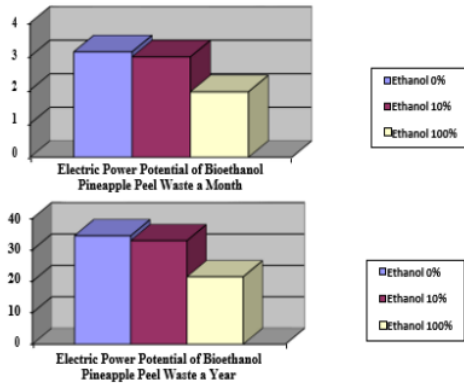

Figure 4 Graph of Bioethanol Power Potential of Pineapple Peel Waste on Fuel Variations (E0,E10,E100)

By using equation 2, we can obtain the power potential results according to the table above. After visualizing the graph, it can be seen that the highest potential power can be generated by bioethanol from pineapple peel waste is highest owned by E0 fuel or pure gasoline, while the lowest power potential is owned by pure bioethanol fuel (E100). The high power potential value of pure gasoline fuel is due to the high amount of electrical energy that can be generated by this fuel. Conversely, the low power potential value of pure ethanol is also due to the low value of electrical energy which is a domino effect of the low specific heating value (LHV) of ethanol. The solution to the low potential value of pure ethanol is by mixing gasoline with ethanol to create an E10 type of fuel (10% ethanol and 90% gasoline). From this fuel mixture, a power potential value is obtained that is close to the power potential value that can be generated by pure gasoline (E0).

C. Calculation of TFC Value of Fuel Mixture E0, E10, E100 (With Test Method with 8 kW Genset Using Mathematical Calculations)

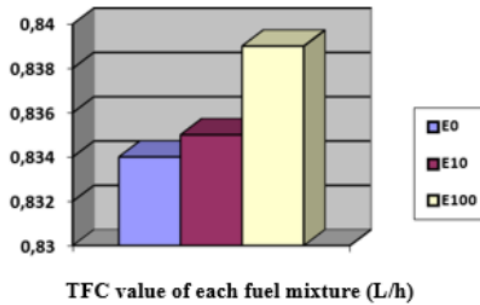

Figure 5. Graph of TFC Comparison of Bioethanol Pineapple Skin Waste on Various Fuels (E0,E10,E100)

After doing the mathematical calculations, the total value of fuel consumption for each type of mixture, both E0, E10, and E100, is obtained according to the graph above. It can be seen that the higher the value of the mixed bioethanol mixture, the higher the fuel consumed by the test generator. From the data, it was found that in the 30-minute test time, the E100 mixture was able to consume 0.839 liters of fuel every hour, or the equivalent of 839 milliliters. It is larger than the fuel that must be consumed by other fuel mixtures such as E0 which is only 0.834 liters an hour (equivalent to 834 milliliters), or E10 which consumes 0.835 liters of fuel (equivalent to 835 milliliters). This means that the type of bioethanol fuel E100 is the most wasteful fuel or consumes a lot of fuel compared to E0 and E10 fuels. The high fuel consumption of each mixture is due to the density value belonging to each of these fuel mixtures. The higher the density value, the more fuel the genset consumes from the mixture.

D. Calculation of SFC Value of E0, E10 Fuel Mixture. Dam E100 (With Test Method with 8 kW Genset Using Mathematical Calculations)

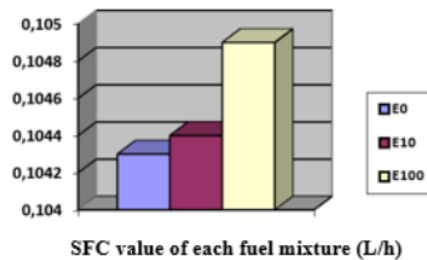

Figure 6 Graph Comparison of SFC Bioethanol Pineapple Peel Waste on Fuel Variations (E0,E10,E100)

From the mathematical calculations performed, the specific fuel consumption value of each fuel mixture is obtained as shown in the graph above. From the graph above, it can be seen that the highest SFC value is in the 100% ethanol fuel mixture or E100. The SFC value of E100 is 0.1049 L/h or equivalent to 104.9 milliliters, 0.5 milliliters larger than the E10 fuel mixture, and 0.6 milliliters larger than the E0 fossil fuel. This indicates that to generate the same 8kW generator engine, E100 fuel requires more fuel than other mixtures. The high SFC value is influenced by the amount of total fuel consumption which is the impact of the density value of each fuel.

E. Calculation of the E0, E10 and E100 Fuel Mix Efficiency (With the Test Method with an 8 kW Genset Using Mathematical Calculations)

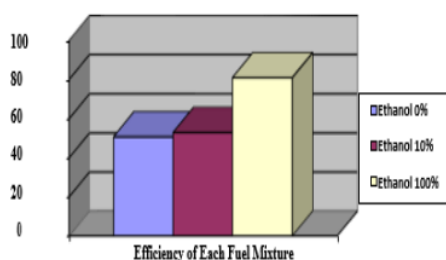

Figure 7 Graph of Comparison of Fuel Efficiency of Bioethanol Pineapple Skin Waste on Fuel Variations

From the calculations that have been done, the efficiency value of the generator engine is obtained with various types of fuel E0, E10, and E100 as shown in the graph above. From the graph, it can be seen that the fuel type E0 or pure fossil fuel has the lowest efficiency value, which is only around 50.82%, while the highest efficiency value is owned by the E100 ethanol fuel mixture with an efficiency of 80.95%. The value of this efficiency is influenced by the consumption value, fuel and the LHV value of each fuel mixture. The greater the value of fuel consumption (TFC) with a low LHV value, the higher the percentage of fuel efficiency. Fossil fuels have the lowest consumption value with the highest LHV, this is the factor that makes the E0 type of fuel have the lowest efficiency. In contrast, E100 fuel has a high fuel consumption value but has a low LHV, it is made of pure ethanol fuel and is the highest efficiency compared to other fuel mixtures, namely 80.95%. This proves that ethanol is the most efficient fuel compared to fossil fuels, namely E0 with a pure concentration of 100% gasoline. However, to prevent damage in the form of corrosion to the engine and the length of time it takes to warm up the generator engine, a 10% ethanol mixture is the best alternative because apart from avoiding the side effects of using pure ethanol, E10 fuel also does not need to modify the engine for the existing generator to anticipate the low calorific

value of pure ethanol. In addition, E10 also has a higher efficiency content than pure gasoline, which is 52.98%, although the efficiency is still lower than pure ethanol.

V. CONCLUSION

After a simulation using the superpro application, the raw material for pineapple skin waste can produce 6,262.63L of bioethanol in a month or 68,871.54L annually. Bioethanol is sourced from 1.2 tons of pineapple skin waste produced from pineapple production in the village of Kuala Nanas, Kampar. The resulting bioethanol is very good quality because it only contains a very small amount of water, which is only 0.0005% with a high ethanol content of 99.9995%. The bioethanol potential of pineapple peel waste can also be used to generate electrical energy, with the greatest energy potential of 71.98 MWh a month or 791.67MWh a year for the E10 mixture, greater than the E100 mixture which has an energy potential of 46.88MWh a month or 515.58 MWh a year. This affects the potential power generated. The power potential generated by the E10 mixture is 2.99MW a month or 32.98MW a year. Higher than pure ethanol which has a power potential of 1.95MW a month and 21.48MW a year. The most suitable fuel mixture to be applied to generators of the E10 fuel type. This is because E10 fuel has a fuel consumption that is not as wasteful as pure ethanol and approaches the consumption of fossil fuels which is more efficient than ethanol fuel. In addition, fuel type E0 or pure fossil fuel has the lowest efficiency value, which is only around 50.82%, while the highest efficiency value is owned by the E100 ethanol fuel mixture with an efficiency of 80.95%.

VI. REFERENCES

- [1] R. M. Arantika Putri, T. Yuanita, and M. Roelianto, "DAYA ANTI BAKTERI EKSTRAK KULIT NANAS (*Ananas comosus*) TERHADAP PERTUMBUHAN BAKTERI *Enterococcus faecalis* ANTIBACTERIAL POTENCY OF PINEAPPLE PEEL EXTRACT (*Ananas comosus*) ON *Enterococcus faecalis* GROWTH," *Con. Dent. J.*, vol. 6, no. 2, p. 61, 2016, doi: 10.20473/cdj.v6i2.2016.61-65.
- [2] E. Astoko, "Konsep Pengembangan Agribisnis Nanas (*Ananas Comosus* L. Merr.) Di Kabupaten Kediri Provinsi Jawa Timur," *Habitat*, vol. 30, no. 19, pp. 111–122, 2019, doi: 10.21776/ub.habitat.2019.030.3.14.
- [3] L. Marlina and W. N. Hainun, "Pembuatan Bioetanol dari Air Kelapa Melalui Fermentasi dan Destilasi-Dehidrasi Dengan Zeolit," *J. TEDC*, vol. 14, no. 3, pp. 255–260, 2020.
- [4] G. P. Arimba, Jasman, Hasanuddin, and Syahrul, "Pemurnian Bioetanol Limbah Kulit Nanas Menggunakan Alat Distilasi Sederhana Model Kolonifluks," *J. Zarah*, vol. 7, no. 1, pp. 22–28, 2019, doi: 10.31629/zarah.v7i1.1173.
- [5] L. Budianingsih1, S. Hadi2, and Susy Edwina 2, "AGRIBISNIS NENAS DI KECAMATAN

- TAMBANG KABUPATEN KAMPAR,” pp. 1–19, 2013.
- [6] E. M. Muhammad (14za Nurhediato1), Shorea Khaswarina2), “ANALISIS USAHATANI NENAS DI DESA KUALU NENAS KECAMATAN TAMBANG KABUPATEN KAMPAR,” *Power Syst. Technol.*, vol. 5, no. 3, pp. 55–60, 2007.
- [7] Ek. Sulistiono, “Buah Nanas (*Ananas comosus* (L.) Merr.) sebagai Sebagai Em-Organik Untuk Meningkatkan Produktifitas Tambak,” *J. Enviscience*, vol. 1, no. 1, p. 4, 2017, doi: 10.30736/jev.v1i1.89.
- [8] E. S. Yusmartini, M. Mardwita, and J. Marza, “Bioethanol from Pineapple Peel with Variation of *Saccharomyces Cerevisiae* Mass and Fermentation Time,” *Indones. J. Fundam. Appl. Chem.*, vol. 6, no. 3, pp. 103–108, 2020, doi: 10.24845/ijfac.v6.i3.103.
- [9] T. S. Nurmalina Rita, *Kelayakan Investasi Pengusahaan Bioetanol*, 1st ed. Bogor: IPB Press, 2010.
- [10] D. P. S. M. K. K. P. dan K. R. Indonesia: 20 *Kimia Organik*, 1st ed., vol. 53, no. 9. Jakarta: Kementerian Pendidikan dan Kebudayaan Republik Indonesia, 2013.
- [11] Direktorat Bioenergi, *Pedoman Investasi Bioenergi energy Investment Guidelines Bionergy*, 1st ed. Jakarta: Direktorat Jenderal Energi Baru, Terbarukan, dan Konservasi Energi Kementerian Energi dan Sumber Daya Mineral, 2016.
- [12] H. Sastrohamidiodio, *Kimia organik dasar*, 1st ed. Jogjakarta: Gadjah Mada University Press, 2016.
- [13] B. N. D. Ischak Ino Netty, Salimi K Yusdza, *Biokimia Dasar I*, 1st ed. Gorontalo, 2017.
- [14] S. Bahri, A. Aji, and F. Yani, “Pembuatan Bioetanol dari Kulit Pisang Kepok dengan Cara Fermentasi menggunakan Ragi Roti,” *J. Teknol. Kim. Unimal*, vol. 7, no. 2, p. 85, 2019, doi: 10.29103/jtku.v7i2.1252.
- [15] L. Y. Setiawan and M. Jelita, “Potensi Listrik Dari Bioetanol Nira Kelapa Sawit Limbah Replanting Studi Kasus PT Duta Palma Nusantara PKS Kuko , Kabupaten Kuantan,” vol. 19, no. 2, pp. 340–349, 2022.

Jurnal PROtek

ORIGINALITY REPORT

9%

SIMILARITY INDEX

8%

INTERNET SOURCES

4%

PUBLICATIONS

4%

STUDENT PAPERS

PRIMARY SOURCES

| | | |
|---|--|----|
| 1 | Submitted to Universitas Khairun Student Paper | 1% |
| 2 | e-journal.unair.ac.id Internet Source | 1% |
| 3 | 123dok.com Internet Source | 1% |
| 4 | distilat.polinema.ac.id Internet Source | 1% |
| 5 | journal.irpi.or.id Internet Source | 1% |
| 6 | Yunilas Yunilas, Ameilia Zuliyanti Siregar, Edhy Mirwhandhono, Adnan Purba, Nelzi Fati, Toni Malvin. "Potensi dan Karakteristik Larutan Mikroorganisme Lokal (MOL) Berbasis Limbah Sayur sebagai Bioaktivator dalam Fermentasi", Journal of Livestock and Animal Health, 2022 Publication | 1% |
| 7 | repo.itera.ac.id Internet Source | 1% |

| | | |
|----|--|------|
| 8 | Lakshana G Nair, Komal Agrawal, Pradeep Verma. "An overview of sustainable approaches for bioenergy production from agro-industrial wastes", Energy Nexus, 2022 Publication | 1 % |
| 9 | ejournal.uin-suska.ac.id Internet Source | 1 % |
| 10 | habitat.ub.ac.id Internet Source | <1 % |
| 11 | conference.unsri.ac.id Internet Source | <1 % |
| 12 | download.atlantis-press.com Internet Source | <1 % |
| 13 | blog.sevagas.com Internet Source | <1 % |
| 14 | www.researchgate.net Internet Source | <1 % |
| 15 | ejurnal.seminar-id.com Internet Source | <1 % |
| 16 | Mutia Nurrahmandani, Sofia Sandi, Asep Indra Munawar Ali. "MORPHOLOGICAL DESCRIPTION OF INTERNAL ORGAN COLOR AND ITS RELATIONSHIP TO BODY WEIGHT OF FREE-RANGE CHICKENS IN THE PALEMBANG LANDFILL ENVIRONMENT", BIOVALENTIA: Biological Research Journal, 2022 | <1 % |

17

ojs.hh.se

Internet Source

<1 %

18

Thangavelu, Saravana Kannan, Abu Saleh Ahmed, and Farid Nasir Ani. "Review on bioethanol as alternative fuel for spark ignition engines", *Renewable and Sustainable Energy Reviews*, 2016.

Publication

<1 %

19

doaj.org

Internet Source

<1 %

20

jurnal.untan.ac.id

Internet Source

<1 %

21

garuda.ristekbrin.go.id

Internet Source

<1 %

Exclude quotes Off

Exclude matches Off

Exclude bibliography Off